

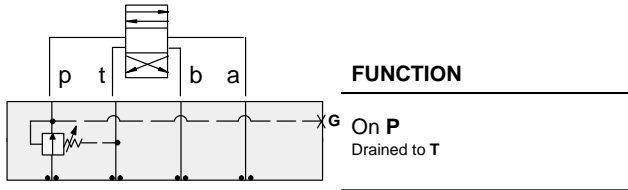

ISO 05 SANDWICH BODIES



- Aluminium rated to 210 bar and SG Iron rated to 350 bar.
- See page viii for ordering cartridge/body and seals. Pressure ratings, material specifications on page xiv.



Reducing Valves

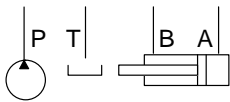
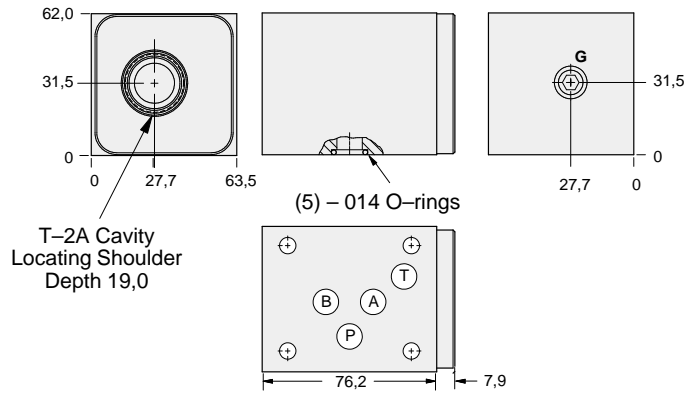

Gauge Port (Plugged)	ALUMINIUM		SG IRON	
	Model Code	List Price	Model Code	List Price
.25 NPTF	BBP		BBP/S	
.25 BSPP	BBP/M		BBP/T	

05 REDUCING

TYPICAL CARTRIDGES USED WITH BODIES SHOWN ABOVE			
	Pilot Operated Reducing Valve		
	PBFB Page 3.06		
	Air Controlled, Pilot Operated Reducing Valve		
	PBFC Page 3.08		
OTHER VALVES:			



ISO 05 SANDWICH BODIES



- Aluminium rated to 210 bar and SG Iron rated to 350 bar.
- See page viii for ordering cartridge/body and seals. Pressure ratings, material specifications on page xiv.

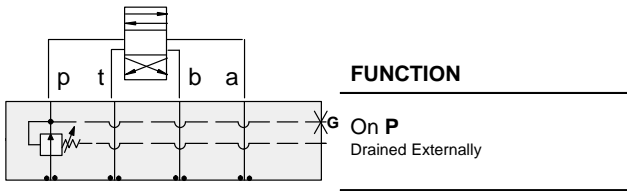

Reducing Valves

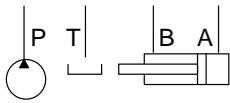
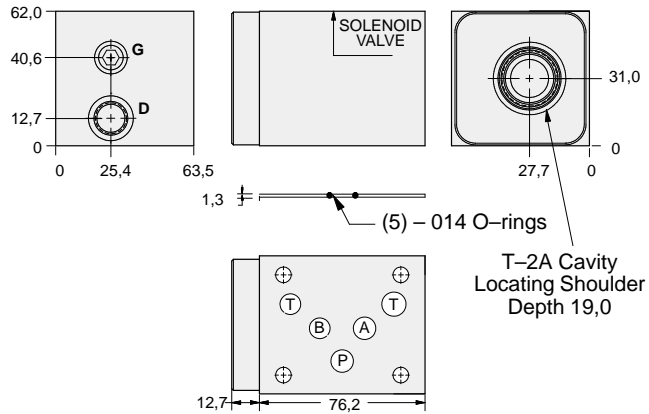

Gauge Port (Plugged)	Drain Port	ALUMINIUM		SG IRON	
		Model Code	List Price	Model Code	List Price
.25 NPTF	SAE-6	BBQ		BBQ/S	
.25 BSPP	.25 BSPP	BBQ/M		BBQ/T	

05 REDUCING

TYPICAL CARTRIDGES USED WITH BODIES SHOWN ABOVE			
	<i>Pilot Operated Reducing Valve</i>		
	PBFB Page 3.06		
	<i>Air Controlled, Pilot Operated Reducing Valve</i>		
	PBFC Page 3.08		
OTHER VALVES:			



ISO 05 SANDWICH BODIES



- Aluminium rated to 210 bar and SG Iron rated to 350 bar.
- See page viii for ordering cartridge/body and seals. Pressure ratings, material specifications on page xiv.

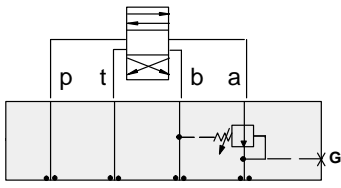

FUNCTION

On A
Drained to B

Reducing Valves

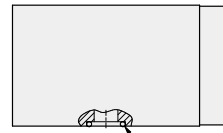
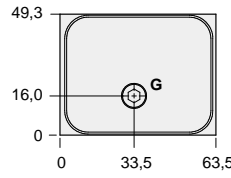

(5) - 014 O-rings

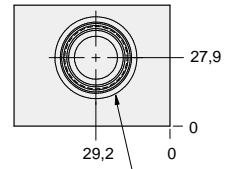

T-2A Cavity
Locating Shoulder
Depth 29,7

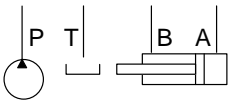
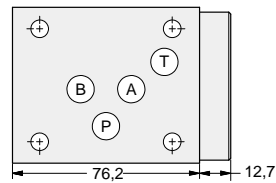

Gauge Port (Plugged)	ALUMINIUM		SG IRON	
	Model Code	List Price	Model Code	List Price
.25 NPTF	BBA		BBA/S	
.25 BSPP	BBA/M		BBA/T	

05 REDUCING

TYPICAL CARTRIDGES USED WITH BODIES SHOWN ABOVE			
	<i>Pilot Operated Reducing Valve</i>		
	PBFB Page 3.06		
	<i>Air Controlled, Pilot Operated Reducing Valve</i>		
	PBFC Page 3.08		
OTHER VALVES:			



ISO 05 SANDWICH BODIES



- Aluminium rated to 210 bar and SG Iron rated to 350 bar.
- See page viii for ordering cartridge/body and seals. Pressure ratings, material specifications on page xiv.

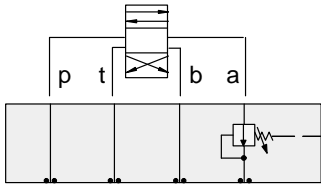

FUNCTION

On A
Drained Externally

Reducing Valves

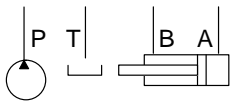
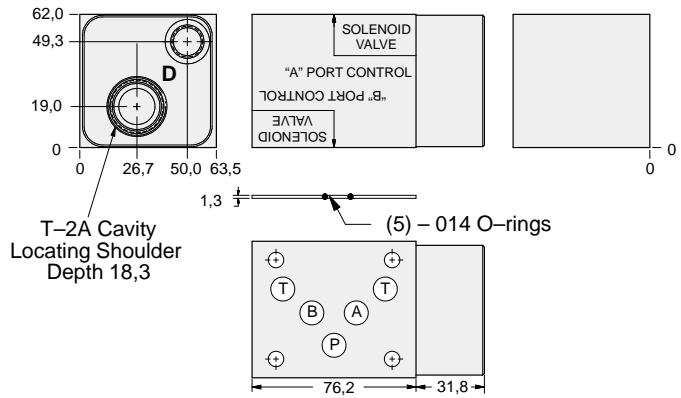

Drain Port	ALUMINIUM		SG IRON	
	Model Code	List Price	Model Code	List Price
SAE-6	BBF		BBF/S	
.25 BSPP	BBF/M		BBF/T	

05 REDUCING

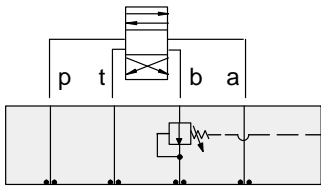

FUNCTION

On B
Drained Externally

Reducing Valves

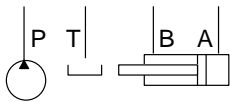
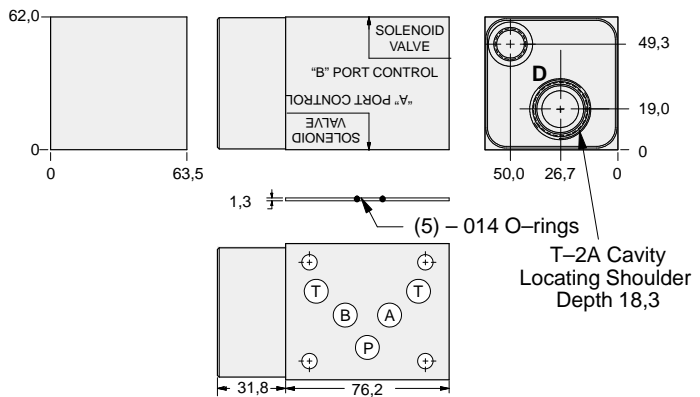

Drain Port	ALUMINIUM		SG IRON	
	Model Code	List Price	Part Number	List Price
SAE-6	BBG		BBG/S	
.25 BSPP	BBG/M		BBG/T	

TYPICAL CARTRIDGES USED WITH BODIES SHOWN ABOVE

	Pilot Operated Reducing Valve		
	PBFB Page 3.06		
	Air Controlled, Pilot Operated Reducing Valve		
	PBFC Page 3.08		
OTHER VALVES:			



ISO 05 SANDWICH BODIES



- Aluminium rated to 210 bar and SG Iron rated to 350 bar.
- See page viii for ordering cartridge/body and seals. Pressure ratings, material specifications on page xiv.

05 REDUCING

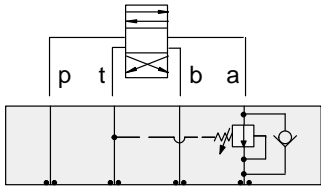

FUNCTION

On A Drain to T
Reverse FF Check

Reducing Valves

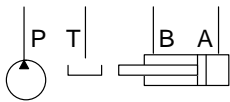
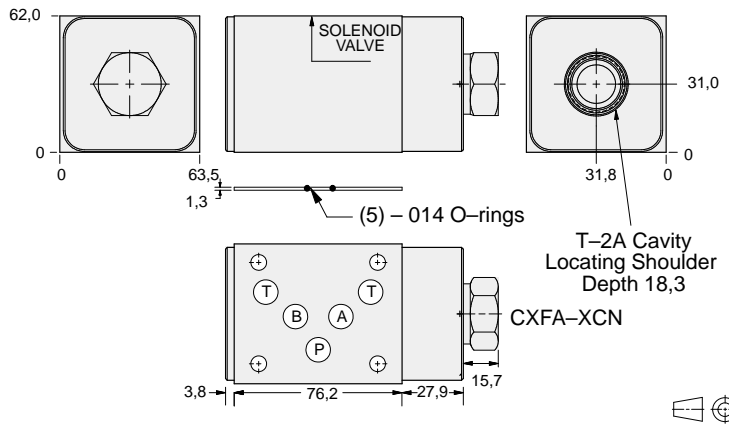

ALUMINIUM		SG IRON	
Model Code	List Price	Model Code	List Price
BB2		BB2/S	

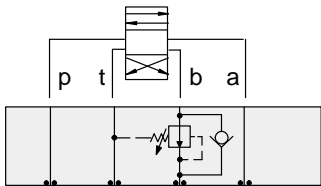

FUNCTION

On B Drain to T
Reverse FF Check

Reducing Valves

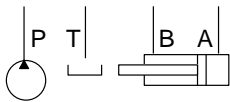
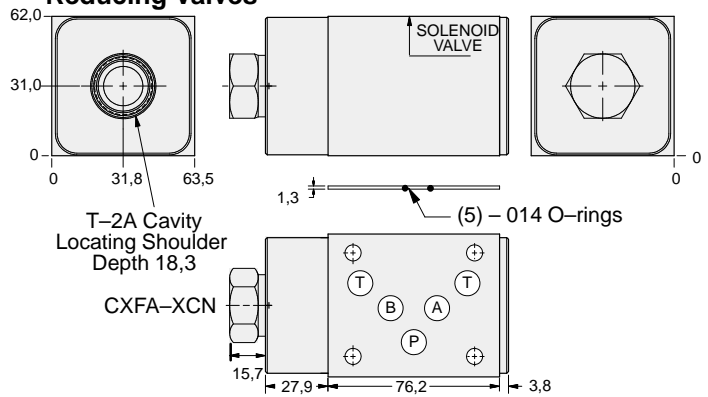

ALUMINIUM		SG IRON	
Model Code	List Price	Part Number	List Price
BB3		BB3/S	

TYPICAL CARTRIDGES USED WITH BODIES SHOWN ABOVE

	Pilot Operated Reducing Valve		
	PBFB Page 3.06		
	Air Controlled, Pilot Operated Reducing Valve		
	PBFC Page 3.08		
OTHER VALVES:			

- Aluminium rated to 210 bar and SG Iron rated to 350 bar.
- See page viii for ordering cartridge/body and seals. Pressure ratings, material specifications on page xiv.

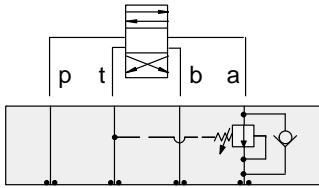

FUNCTION

On A Drain to T
Reverse FF Check

Reducing Valves

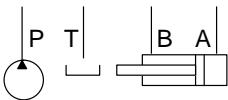
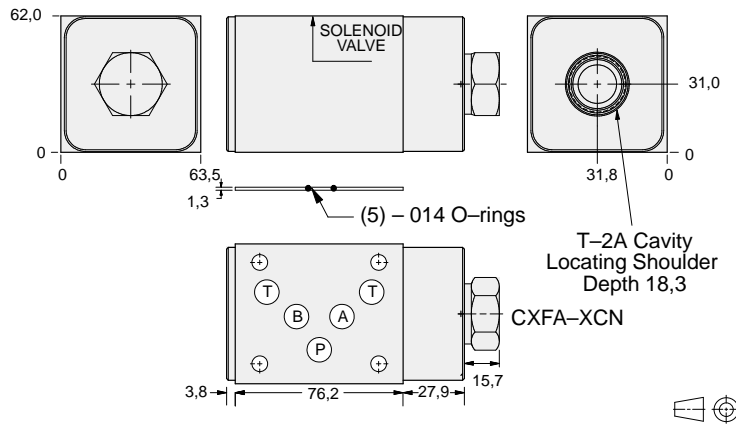

ALUMINIUM		SG IRON	
Model Code	List Price	Model Code	List Price
BB2		BB2/S	

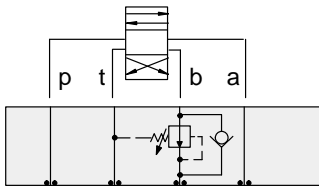

FUNCTION

On B Drain to T
Reverse FF Check

Reducing Valves

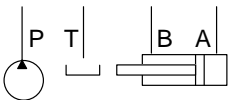
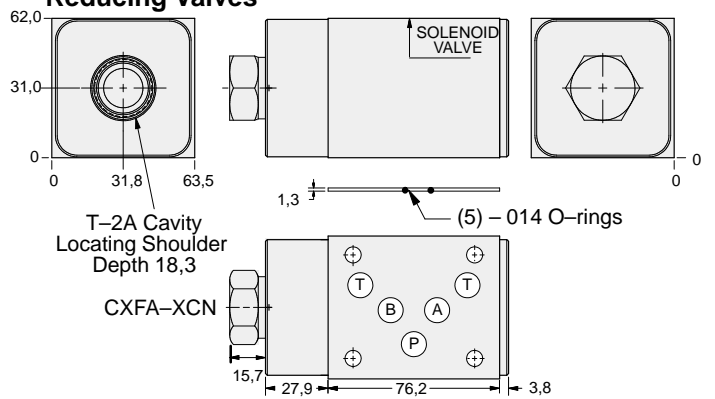

ALUMINIUM		SG IRON	
Model Code	List Price	Part Number	List Price
BB3		BB3/S	

TYPICAL CARTRIDGES USED WITH BODIES SHOWN ABOVE

	Pilot Operated Reducing Valve		
	PBFB Page 3.06		
	Air Controlled, Pilot Operated Reducing Valve		
	PBFC Page 3.08		
OTHER VALVES:			



ISO 05 SANDWICH BODIES



- Aluminium rated to 210 bar and SG Iron rated to 350 bar.
- See page viii for ordering cartridge/body and seals. Pressure ratings, material specifications on page xiv.

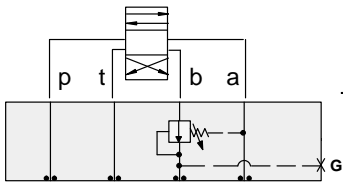

FUNCTION

On B
Drained to A

Reducing Valves

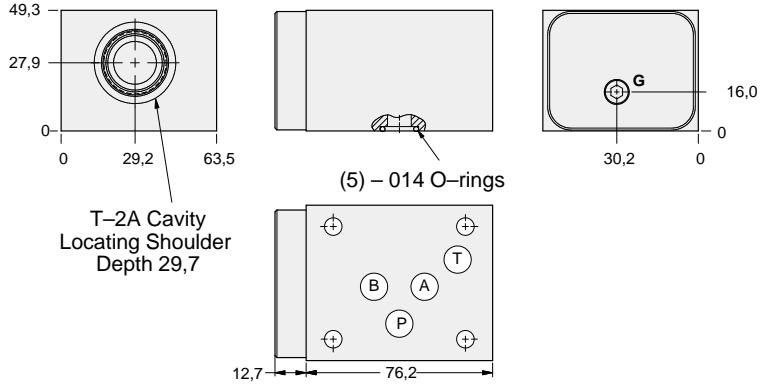

05 REDUCING

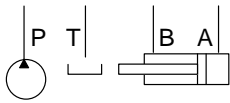

Gauge Port (Plugged)	ALUMINIUM		SG IRON	
	Model Code	List Price	Model Code	List Price
.25 NPTF	BBB		BBB/S	
.25 BSPP	BBB/M		BBB/T	

TYPICAL CARTRIDGES USED WITH BODIES SHOWN ABOVE

TYPICAL CARTRIDGES USED WITH BODIES SHOWN ABOVE			
	<i>Pilot Operated Reducing Valve</i>		
	PBFB Page 3.06		
OTHER VALVES:			



ISO 05 SANDWICH BODIES



- Aluminium rated to 210 bar and SG Iron rated to 350 bar.
- See page viii for ordering cartridge/body and seals. Pressure ratings, material specifications on page xiv.

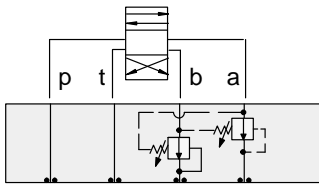

FUNCTION

On **A** and **B**
Drains to Opposite Port

Reducing Valves

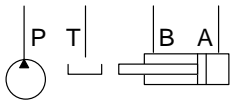
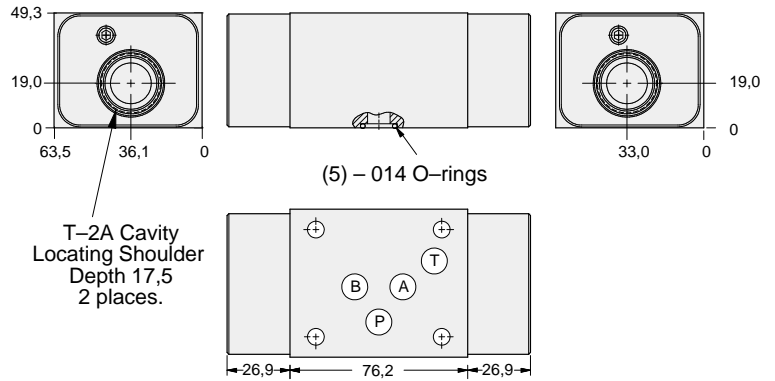

ALUMINIUM		SG IRON	
<i>Model Code</i>	<i>List Price</i>	<i>Model Code</i>	<i>List Price</i>
BBY		BBY/S	



05 REDUCING

TYPICAL CARTRIDGES USED WITH BODIES SHOWN ABOVE			
	<i>Pilot Operated Reducing Valve</i>		
	PBFB Page 3.06		
OTHER VALVES:			