

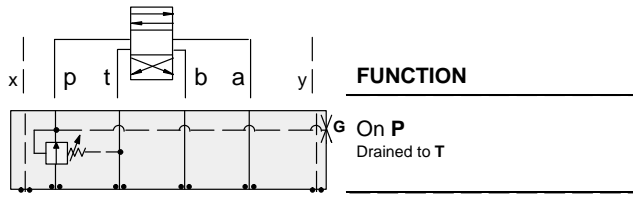

ISO 07 SANDWICH BODIES



- Aluminium rated to 210 bar and SG Iron rated to 350 bar.
- See page viii for ordering cartridge/body and seals. Pressure ratings, material specifications on page xiv.



Reducing Valves

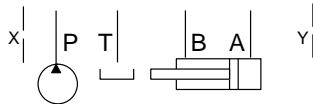
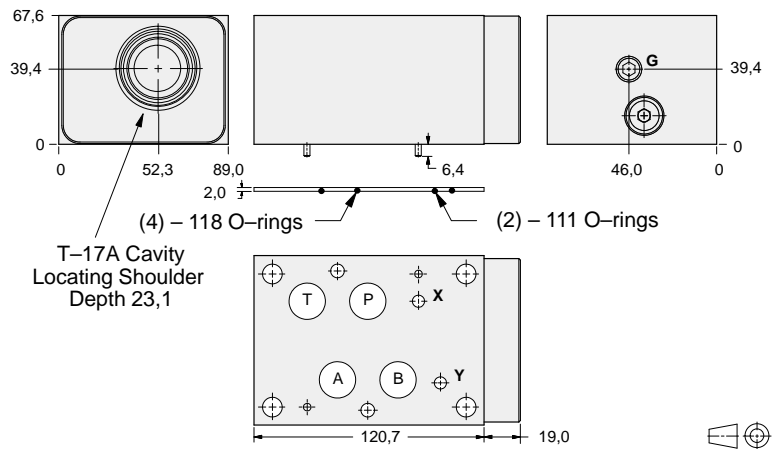

Gauge Port (Plugged)	ALUMINIUM		SG IRON	
	Model Code	List Price	Model Code	List Price
.25 NPTF	BKP		BKP/S	
.25 BSPP	BKP/M		BKP/T	

TYPICAL CARTRIDGES USED WITH BODIES SHOWN ABOVE

	Pilot Operated Reducing Valve		
	PBHB Page 3.07		
	Air Controlled, Pilot Operated Reducing Valve		
	PBHC Page 3.09		
OTHER VALVES:			



ISO 07 SANDWICH BODIES



- Aluminium rated to 210 bar and SG Iron rated to 350 bar.
- See page viii for ordering cartridge/body and seals. Pressure ratings, material specifications on page xiv.

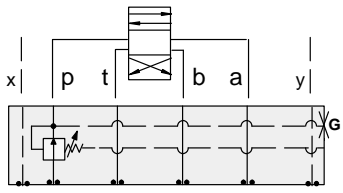

FUNCTION

On P
Drained Externally

Reducing Valves

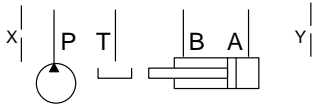
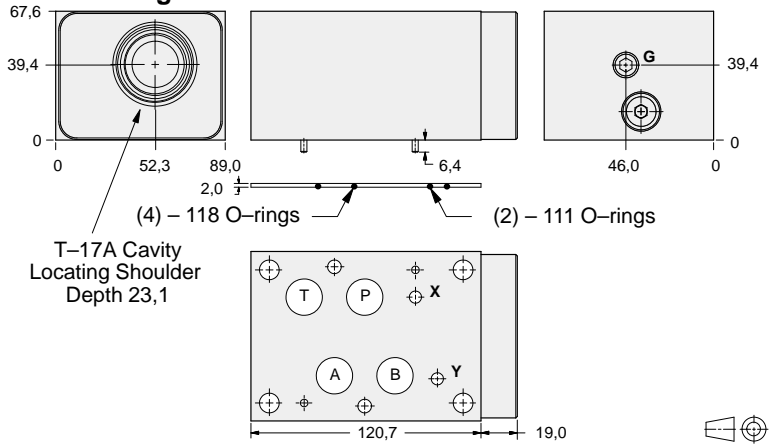

Gauge Port (Plugged)	Drain Port	ALUMINIUM		SG IRON	
		Model Code	List Price	Model Code	List Price
.25 NPTF	SAE-6	BKQ		BKQ/S	
.25 BSPP	.25 BSPP	BKQ/M		BKQ/T	

07 REDUCING

TYPICAL CARTRIDGES USED WITH BODIES SHOWN ABOVE

	Pilot Operated Reducing Valve		
	PBHB Page 3.07		
	Air Controlled, Pilot Operated Reducing Valve		
	PBHC Page 3.09		
OTHER VALVES:			



ISO 07 SANDWICH BODIES



- Aluminium rated to 210 bar and SG Iron rated to 350 bar.
- See page viii for ordering cartridge/body and seals. Pressure ratings, material specifications on page xiv.

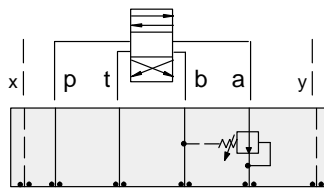

FUNCTION

On A
Drained to B

Reducing Valves

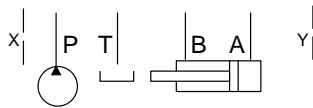
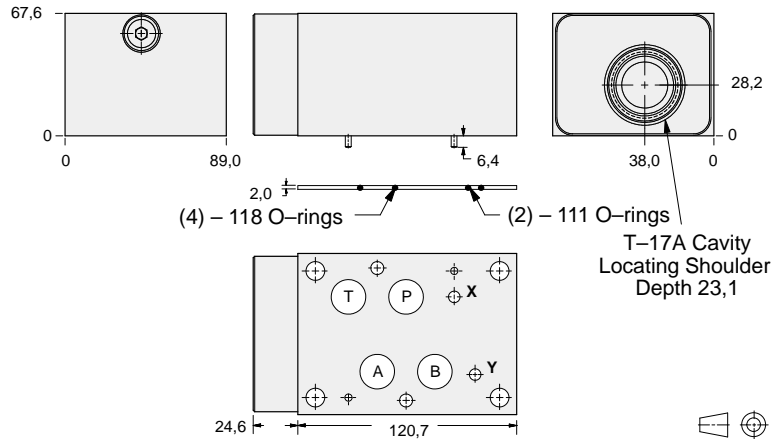

ALUMINIUM		SG IRON	
Model Code	List Price	Model Code	List Price
BAK		BAK/S	

TYPICAL CARTRIDGES USED WITH BODIES SHOWN ABOVE			
	Pilot Operated Reducing Valve		
	PBHB Page 3.07		
OTHER VALVES:			



ISO 07 SANDWICH BODIES



- Aluminium rated to 210 bar and SG Iron rated to 350 bar.
- See page viii for ordering cartridge/body and seals. Pressure ratings, material specifications on page xiv.

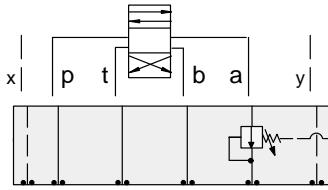

FUNCTION

On A
Drained Externally

Reducing Valves

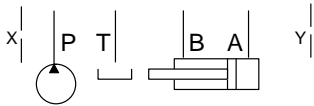
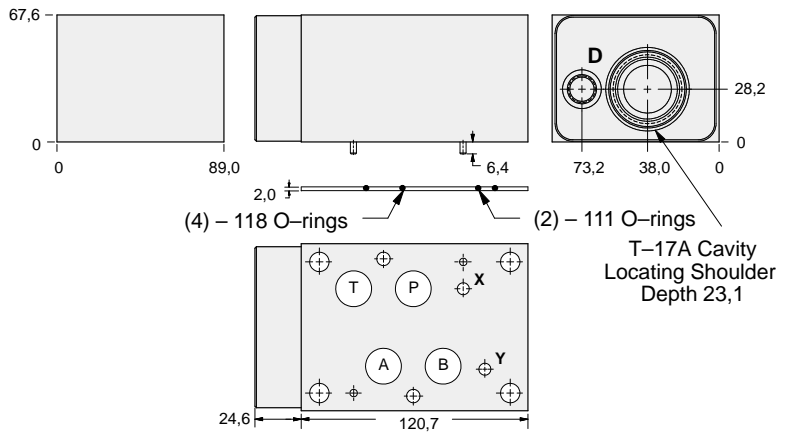

Drain Port	ALUMINIUM		SG IRON	
	Model Code	List Price	Model Code	List Price
SAE-6	BKC		BKC/S	
.25 BSPP	BKC/M		BKC/T	

07 REDUCING

TYPICAL CARTRIDGES USED WITH BODIES SHOWN ABOVE

	Pilot Operated Reducing Valve		
	PBHB Page 3.07		
	Air Controlled, Pilot Operated Reducing Valve		
	PBHC Page 3.09		
OTHER VALVES:			



ISO 07 SANDWICH BODIES



- Aluminium rated to 210 bar and SG Iron rated to 350 bar.
- See page viii for ordering cartridge/body and seals. Pressure ratings, material specifications on page xiv.

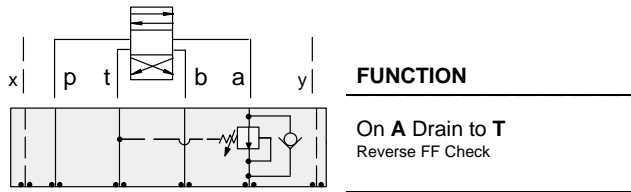

Reducing Valves

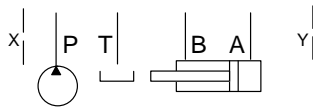
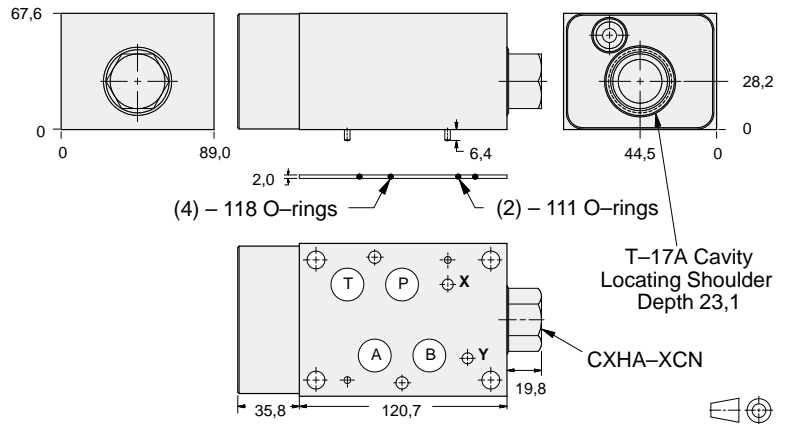

ALUMINIUM		SG IRON	
Model Code	List Price	Model Code	List Price
BK2		BK2/S	

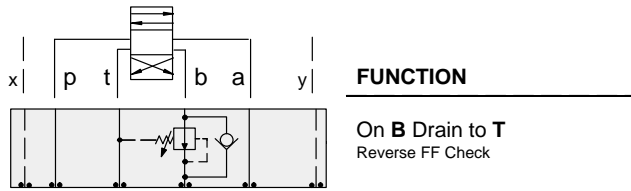

Reducing Valves

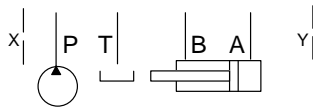
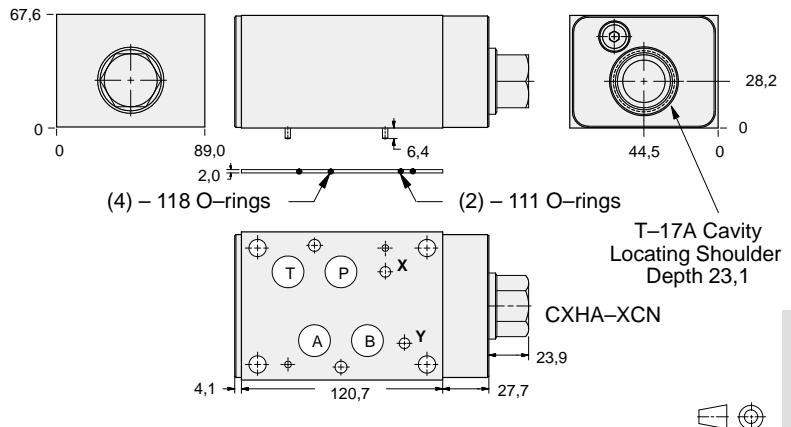

ALUMINIUM		SG IRON	
Model Code	List Price	Part Number	List Price
BKJ		BKJ/S	

TYPICAL CARTRIDGES USED WITH BODIES SHOWN ABOVE			
	Pilot Operated Reducing Valve		
	PBHB Page 3.07		
	Air Controlled, Pilot Operated Reducing Valve		
	PBHC Page 3.09		
OTHER VALVES:			



ISO 07 SANDWICH BODIES



- Aluminium rated to 210 bar and SG Iron rated to 350 bar.
- See page viii for ordering cartridge/body and seals. Pressure ratings, material specifications on page xiv.

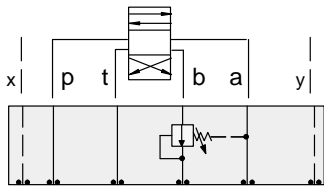

FUNCTION

On B
Drained to A

Reducing Valves

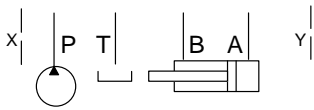
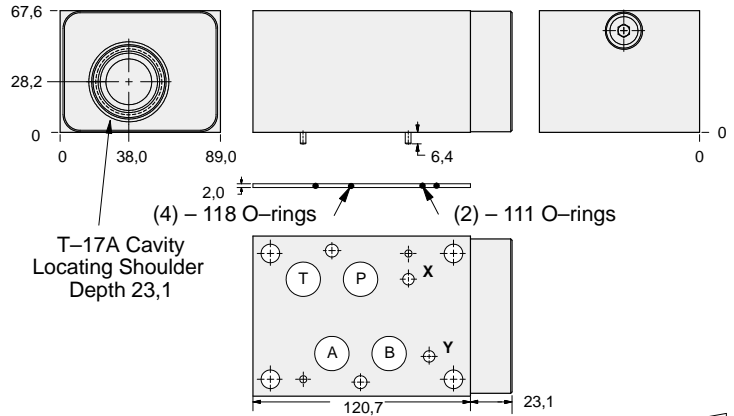

ALUMINIUM		SG IRON	
Model Code	List Price	Model Code	List Price
BKB		BKB/S	

07 REDUCING

TYPICAL CARTRIDGES USED WITH BODIES SHOWN ABOVE			
	Pilot Operated Reducing Valve		
	PBHB Page 3.07		
OTHER VALVES:			



ISO 07 SANDWICH BODIES



- Aluminium rated to 210 bar and SG Iron rated to 350 bar.
- See page viii for ordering cartridge/body and seals. Pressure ratings, material specifications on page xiv.

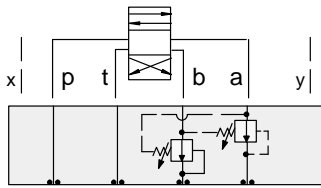

FUNCTION

On **A** and **B**
Drains to Opposite Port

Reducing Valves

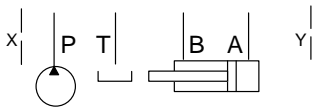
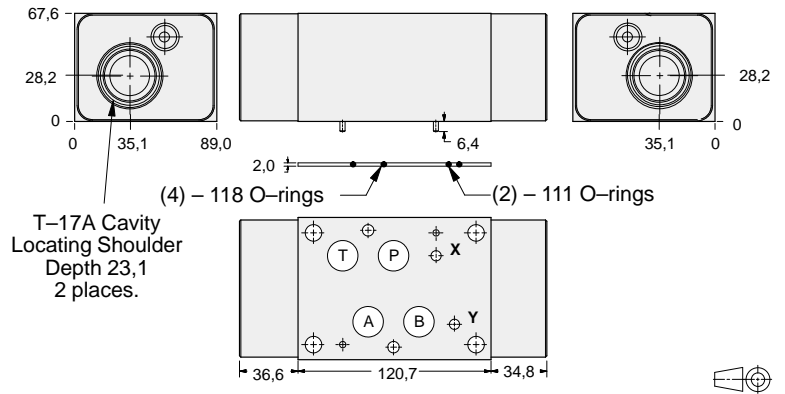

ALUMINIUM		SG IRON	
Model Code	List Price	Model Code	List Price
BKY		BKY/S	

TYPICAL CARTRIDGES USED WITH BODIES SHOWN ABOVE			
	Pilot Operated Reducing Valve		
	PBHB Page 3.07		
OTHER VALVES:			