

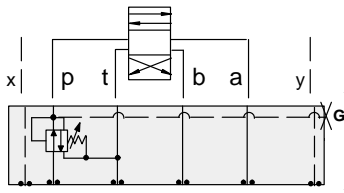

ISO 07 SANDWICH BODIES



- Aluminium rated to 210 bar and SG Iron rated to 350 bar.
- See page viii for ordering cartridge/body and seals. Pressure ratings, material specifications on page xiv.



FUNCTION

On P Tank to T
Drained to T

Reducing/Relieving Valves

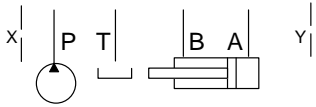
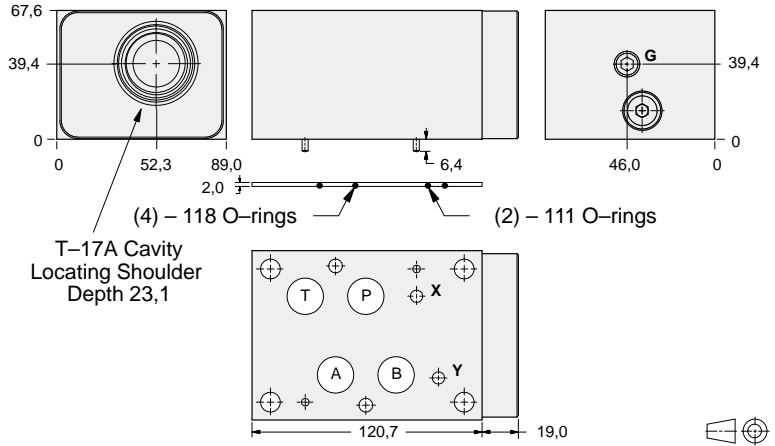

Gauge Port (Plugged)	ALUMINIUM		SG IRON	
	Model Code	List Price	Model Code	List Price
.25 NPTF	BKP		BKP/S	
.25 BSPP	BKP/M		BKP/T	

07 REDUCING/RELIEVING

TYPICAL CARTRIDGES USED WITH BODIES SHOWN ABOVE			
	Pilot Operated Reducing/Relieving Valve		
	PPHB Page 3.11		
	Air Controlled, Pilot Operated Reducing/Relieving Valve		
	PPHC Page 3.13		
OTHER VALVES:			



ISO 07 SANDWICH BODIES



- Aluminium rated to 210 bar and SG Iron rated to 350 bar.
- See page viii for ordering cartridge/body and seals. Pressure ratings, material specifications on page xiv.

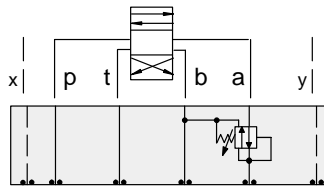

FUNCTION

On A Tank to B
Drained to B

Reducing/Relieving Valves

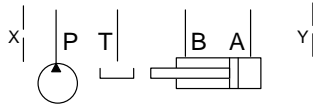
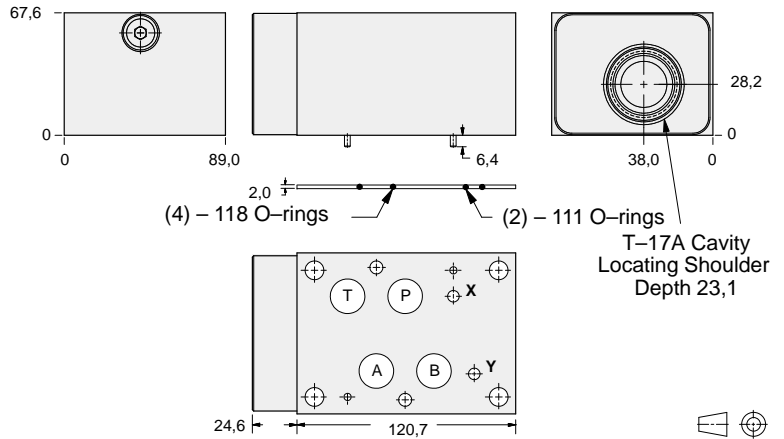

ALUMINIUM		SG IRON	
Model Code	List Price	Model Code	List Price
BAK		BAK/S	

TYPICAL CARTRIDGES USED WITH BODIES SHOWN ABOVE

	<i>Pilot Operated Reducing/Relieving Valve</i>		
	PPHB Page 3.11		
OTHER VALVES:			



ISO 07 SANDWICH BODIES



- Aluminium rated to 210 bar and SG Iron rated to 350 bar.
- See page viii for ordering cartridge/body and seals. Pressure ratings, material specifications on page xiv.

Reducing/Relieving Valves

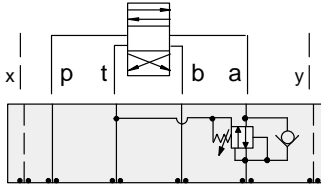

FUNCTION

On A Tank to T
Drained to T
Reverse FF Check

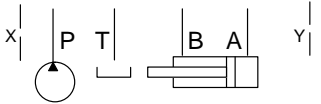
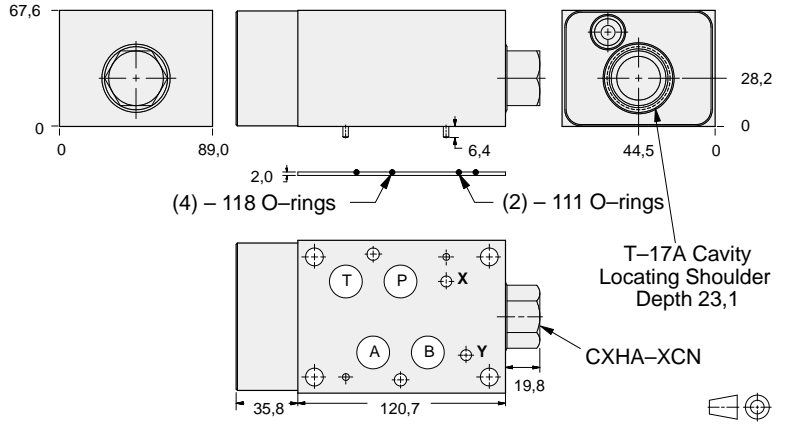

ALUMINIUM		SG IRON	
Model Code	List Price	Model Code	List Price
BK2		BK2/S	

Reducing/Relieving Valves

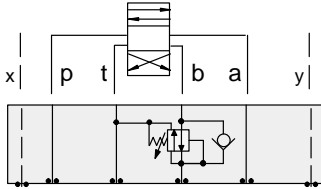

FUNCTION

On B Tank to T
Drained to T
Reverse FF Check

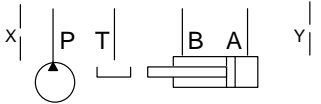
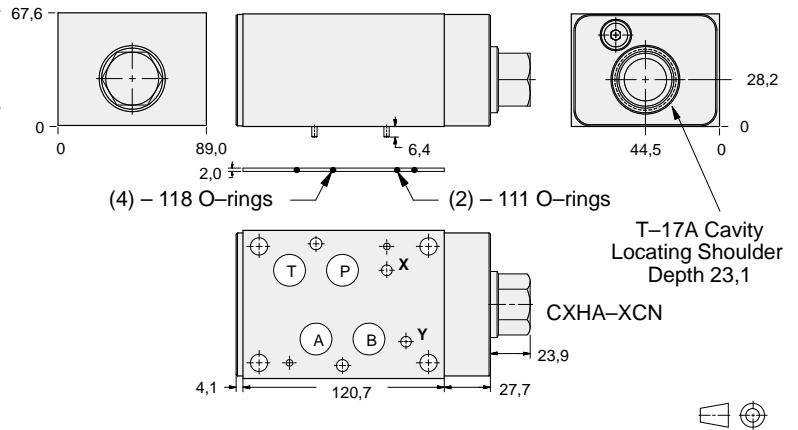

ALUMINIUM		SG IRON	
Model Code	List Price	Part Number	List Price
BKJ		BKJ/S	

07 REDUCING/RELIEVING

TYPICAL CARTRIDGES USED WITH BODIES SHOWN ABOVE

	Pilot Operated Reducing/Relieving Valve		
	PPHB Page 3.11		
	Air Controlled, Pilot Operated Reducing/Relieving Valve		
	PPHC Page 3.13		
OTHER VALVES:			



ISO 07 SANDWICH BODIES



- Aluminium rated to 210 bar and SG Iron rated to 350 bar.
- See page viii for ordering cartridge/body and seals. Pressure ratings, material specifications on page xiv.

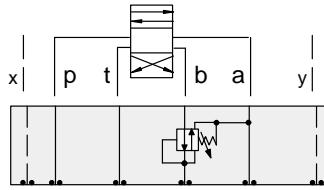

FUNCTION

On **B** Tank to **A**
Drained to **A**

Reducing/Relieving Valves

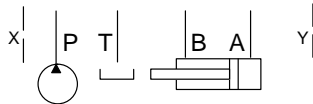
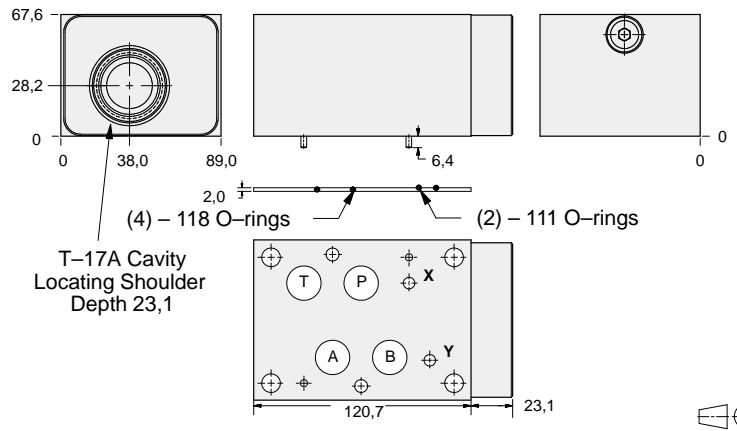

ALUMINIUM		SG IRON	
Model Code	List Price	Model Code	List Price
BKB		BKB/S	

TYPICAL CARTRIDGES USED WITH BODIES SHOWN ABOVE			
	<i>Pilot Operated Reducing/Relieving Valve</i>		
	PPHB Page 3.11		
OTHER VALVES:			



ISO 07 SANDWICH BODIES



- Aluminium rated to 210 bar and SG Iron rated to 350 bar.
- See page viii for ordering cartridge/body and seals. Pressure ratings, material specifications on page xiv.

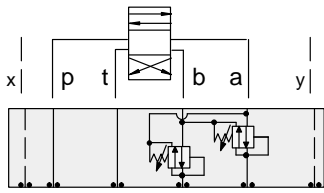

FUNCTION

On **A** and **B**
Tanks and Drains to
Opposite Port

Reducing/Relieving Valves

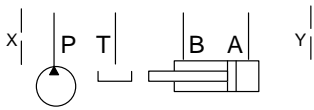
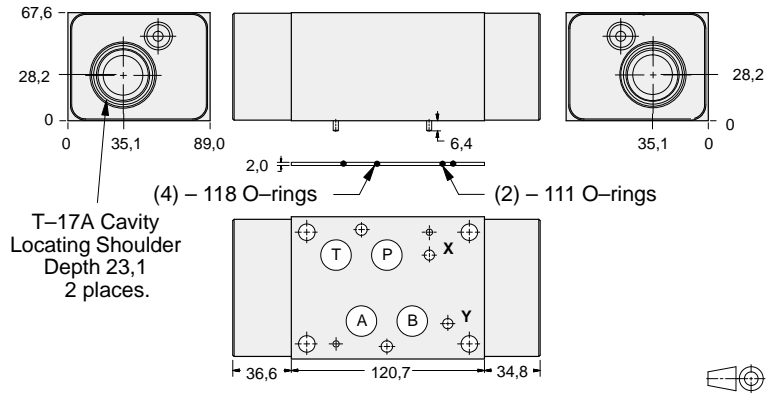

ALUMINIUM		SG IRON	
Model Code	List Price	Model Code	List Price
BKY		BKY/S	

07 REDUCING/RELIEVING

TYPICAL CARTRIDGES USED WITH BODIES SHOWN ABOVE			
	Pilot Operated Reducing/Relieving Valve		
	PPHB Page 3.11		
OTHER VALVES:			